

















Neue Arbeitsbühne - machine neuve - new vehicle - veicolo nuovo

	Multitel Pagliero		Nissan
Type	160 ALU Hybrid	Type	Cabstar 35.13
SN°	n/a		Euro 6
Year	n/a	Year	n/a
h	n/a	km	n/a
	16.30 m		6.85 m
	7.50 m (200 kg) 10.20 m (80 kg)		2.05 m
	1.40 m x 0.70 m		2.78 m
	60° / 60°		3,5 t
	200 kg		230 V
	2.05 m		2WD

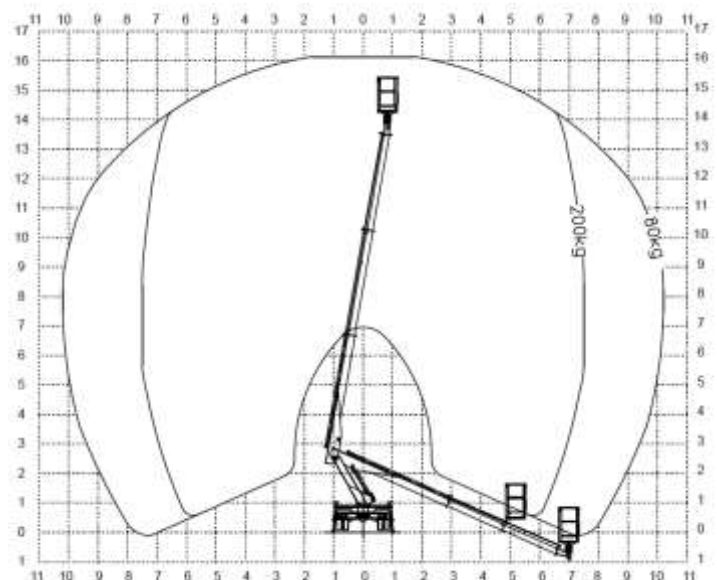

Preis auf Anfrage / Prix sur demande
Price on request / Prezzo su richiesta



Olivier Wolf  +41 79 349 3910  owolf@skyworkertrade.ch