













## Neue Arbeitsbühne - machine neuve - new vehicle - veicolo nuovo

	JLG		2.82 m
<b>Type</b>	Toucan 10E-L		0.99 m
<b>SN°</b>	n/a		1.99 m
<b>Year</b>	n/a		25 %
<b>h</b>	n/a		2'600 kg
	10.10 m		230 V / 24 V
	3.38 m		2WD / 2WS
	0.90 m x 0.70 m		
	n/a		
	200 kg		



Preis auf Anfrage / Prix sur demande  
Price on request / Prezzo su richiesta

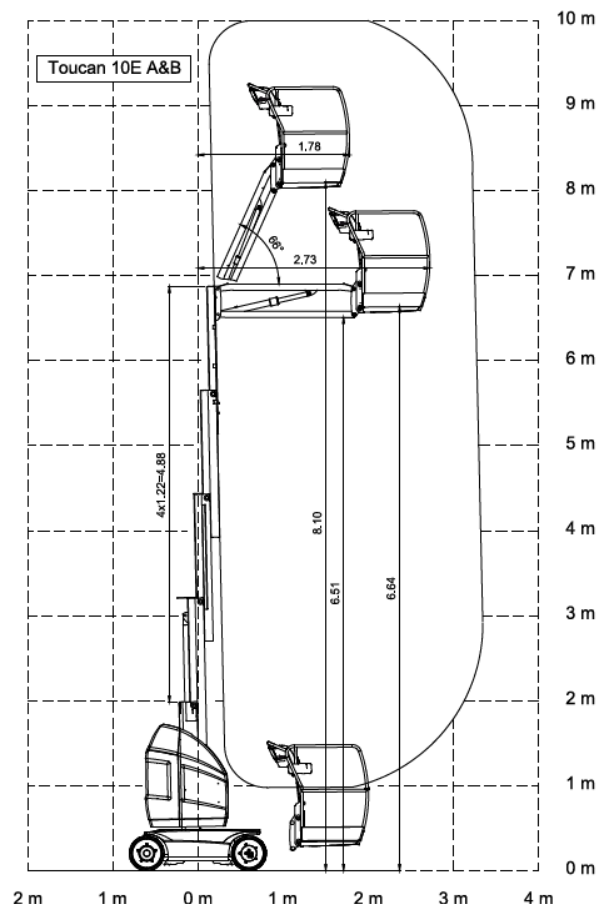

Olivier Wolf ☎ +41 79 690 7706 ✉ owolf@skyworkertrade.ch