













Neue Arbeitsbühne - machine neuve - new vehicle - veicolo nuovo

| | | | |
|---|-----------------|---|--------------|
|  | JLG |  | 3.65 m |
| Type | Toucan 12E Plus |  | 1.20 m |
| SN° | n/a |  | 1.99 m |
| Year | n/a |  | 25 % |
| h | n/a |  | 4'900 kg |
|  | 12.65 m |  | 230 V / 48 V |
|  | 6.70 m |  | 2WD / 2WS |
|  | 1.05 m x 0.70 m | | |
|  | n/a | | |
|  | 200 kg | | |



Preis auf Anfrage / Prix sur demande
Price on request / Prezzo su richiesta

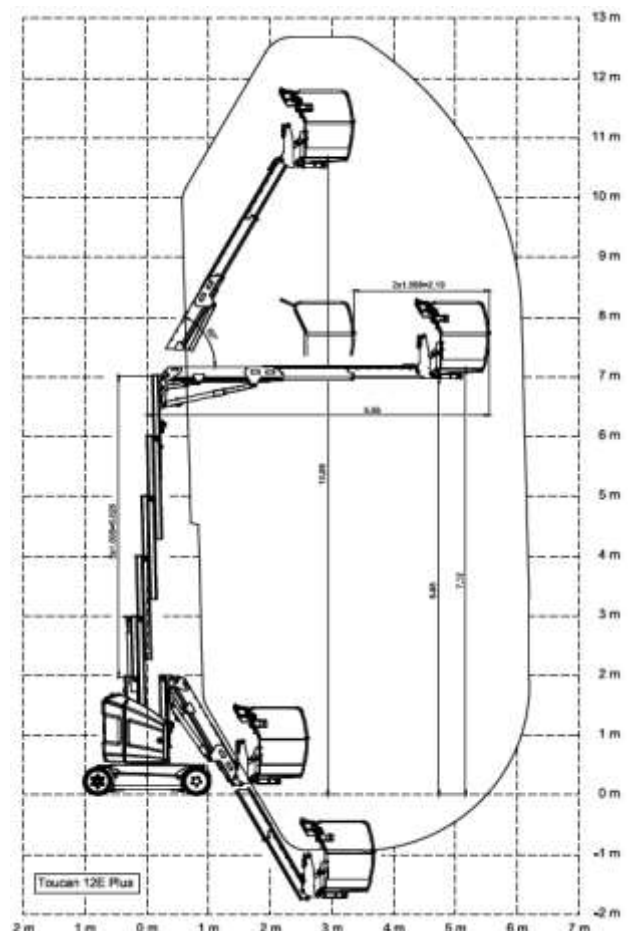

Olivier Wolf ☎ +41 79 690 7706 ✉ owolf@skyworkertrade.ch